

LAYOUT Geyssel AZ - 500 (800-1600kg)

Aufzugsschacht

Maschinenraum - Plan

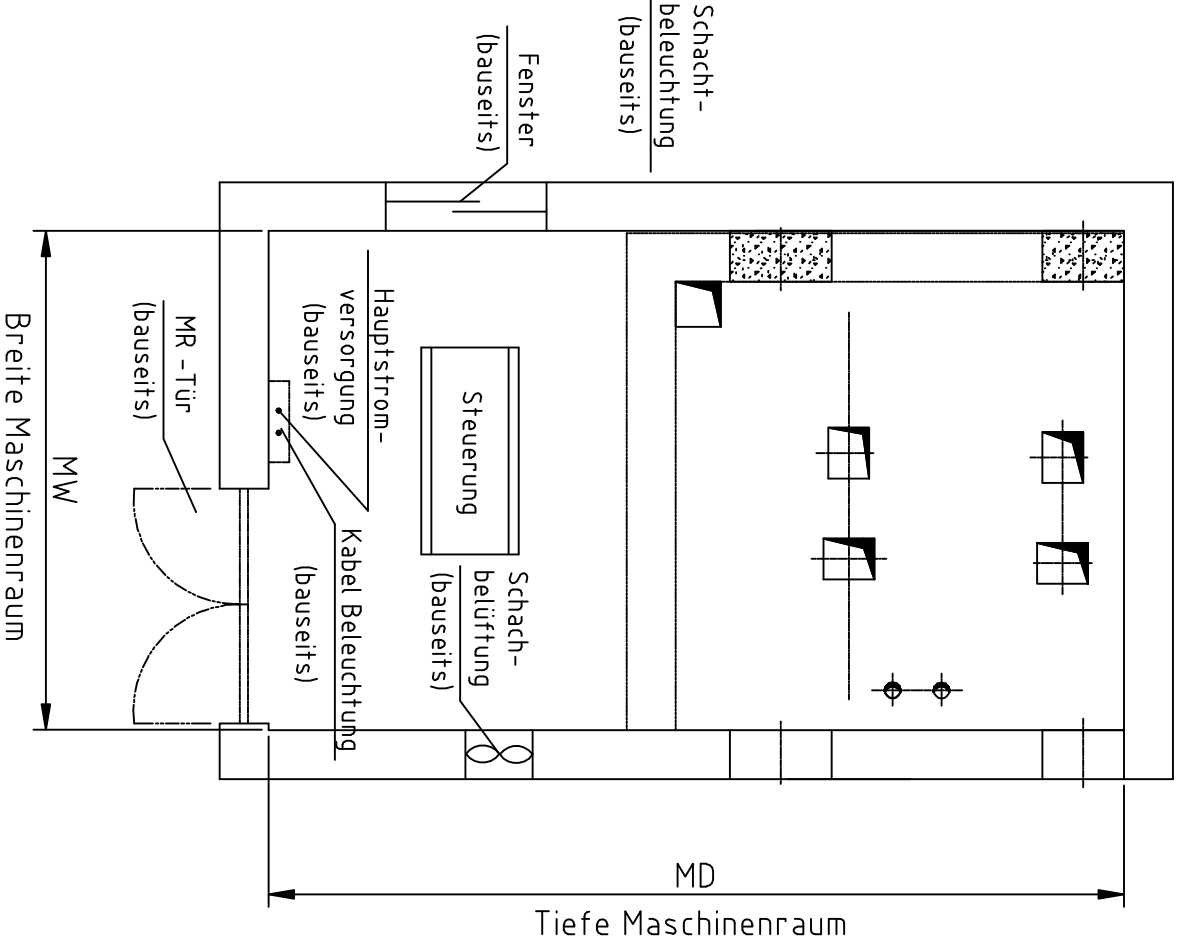
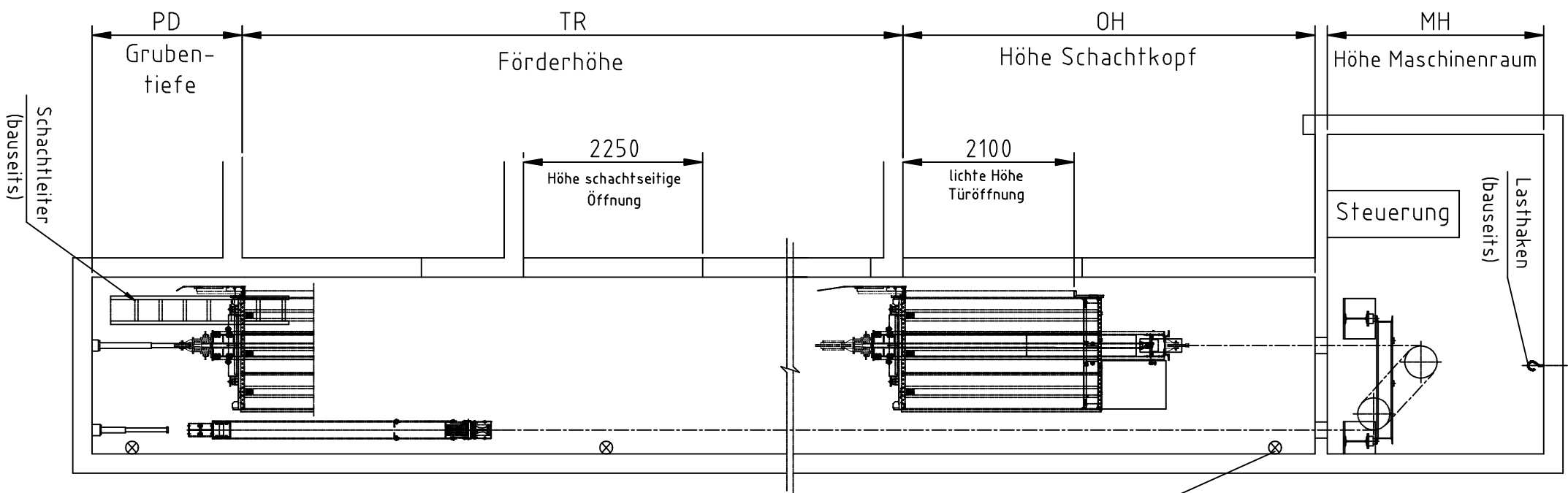

Aufzugsschacht - Plan

